

**Resource
Magazine's**

**OUTSTANDING
INNOVATIONS
2001**



AE50

AE50 2001

Transforming a new or improved machine, system or component from an idea into an end-user product can take years of planning, tests and revisions. The 2001 AE50 awards honor the companies that overcame engineering challenges to bring an innovation to the marketplace.

“Engine selection created our first concern,” writes an AE50 entrant who developed a wood chipping device. “Machine size requirements limited us to mounting the engine in-line — radiator facing rearward. This created the need for a suitable right-angle drive gearbox that would be compact and that would handle at least 250 horsepower.”

Many of this year’s AE50 winners crossed such hurdles to develop products for the agricultural, food and biological systems industries. Jackie Elowsky, AE50 coordinator and *Resource* features editor, says the winners list for the 2001 competition includes a wide variety of high-quality entries.

“The judges have been fine tuning their ranking criteria,” she says. “The competition gets tougher each year so only the best products are honored.”

The competition, sponsored by *Resource*, is judged by an ASAE committee representing all factions of the agricultural, food, biological and related systems engineering professions. This year, the expert panel selected the best of products first introduced to the marketplace during 2000. These products are expected to save producers time,

costs and labor while improving user safety.

Problem solving is a major goal in designs whether one is developing a better way to spread manure, water a golf course or monitor weather conditions. Environmental concerns must also be factored in while keeping production and operating costs low.

One entrant writes. “This new method contains less parts and is less complicated than past methods.”

Another explains: “World wide customer focus groups were a key element in defining the requirements and confirming product specifications for this program. Three-dimensional computer design tools were used to design parts, evaluate stress and check fit up. Prototypes were built using production tools and methods to obtain manufacturing input and develop quality control processes well before production began.”

The annual AE50 program has been honoring engineering achievements for more than a decade. The AE50 is the only awards program of its kind, Elowsky says, to reward companies for developments in specific areas of agricultural, food and biological systems.

“Farmers can be more productive by increasing their time operating in the field with less time spent adjusting for varying conditions,” an equipment manufacturer reports in its award winning entry. “Precise and consistent



depth control will result in lower fuel requirements, moisture conservation and better fertilizer placement. Improved overall soil management will lower input costs and increase yields. These improvements will lower food and product costs for consumers.”

Prices for end-products winning this year’s contest range from 45 cents for an irrigation drip fitting to more than \$200,000 for a tractor. Although equipment that uses computer or satellite technology may be the most sophisticated for some countries, for others merely automating a previously hand-operated device deserves AE50 recognition.

“In designing agricultural machines and equipment, it is important to consider the characteristics of the users even more than the technical process requirements,” an entrant writes about new cassava-grating equipment. “Investing in a machine is a critical decision by farmers and processors who have very limited resources. In Africa, social norms dictate crop and food processing as a sole responsibility of women. The grater caters to women processors’ requirements because it is simple to operate and maintain.”

Other new, higher-tech products, such as a global positioning system steering apparatus, may have applications in many areas.

“Farmers that use this product will produce food more efficiently with lower

input costs and with fewer tractors than ever before,” its designers write. “In the near future, the machine navigation and guidance technologies developed for this product will likely be used in a number of related industries. The mining, construction and aviation industries are all likely candidates for modified versions of this product.”

Many of the new ideas are patented and their names trademarked. Some may become household words in the future. Others will be improved upon as technology advances.

In the following comments, one AE50 entrant sums up how a company perceives its product development goals:

“Today’s farmers are faced with a large set of variables that they must contend with and manage

to achieve overall farm profitability. Some of these variables include crop and variety selection, tillage and harvesting equipment choices, residue management and contending with the weather.

“Our invention may profoundly alter the way researchers and farmers think of and manage their crop residues in the future.”

For information on next year’s competition, contact Elowsky at 616-429-0300 ext. 313 or elowsky@asae.org.

Information on the AE50 is also available at the ASAE Web site: www.asae.org.



● Tractor tire is more turf-friendly to golf courses

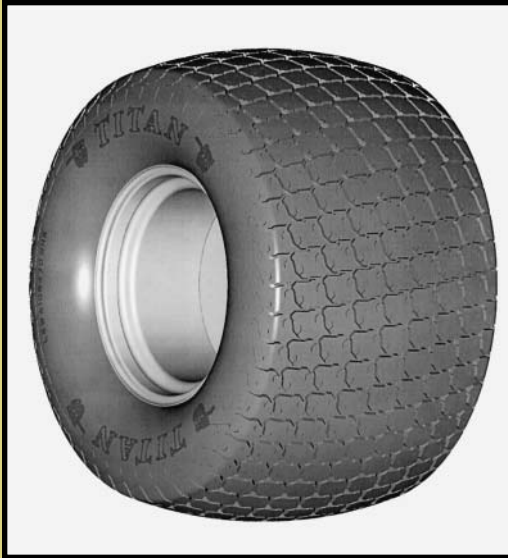

The LSW610R470 G30 Turf Tire was developed specifically for fine turf applications such as golf courses, sod farms and ballparks. This tire, with its radial construction, delivers reduced rolling resistance — for reduced fuel consumption — and increased footprint over a bias tire. The LSW's lower sidewall creates less bounce, road lope and driver fatigue while increasing vertical and lateral stability. The LSW's heavier sidewall and special rim provide puncture resistance. This tire features rounded shoulders and a block-shaped tread for less turf damage during turns and a wide footprint for improved stability, reduced ground disturbance and maximum flotation. The LSW fits Deere 5000 series tractors, Massey Ferguson 1100 series tractors and similar machines.

Titan Tire Corp.
Mogadore, Ohio, USA; 330-798-7387

AE50 OUTSTANDING



INNOVATIONS 2001

● Electronic tool takes guesswork out of fertilizer application

The Hydro N-Sensor provides farmers with information about nitrogen requirements for a grain crop. The sensor is mounted atop the cabin of a tractor that pulls a spreader or sprayer. The online system analyses spectral information of reflected daylight from the plant population to measure plant nitrogen requirements and send a recommendation to the spreader or sprayer in one working cycle. Plants receive the correct amount of fertilizer that their metabolism can use. Unused fertilizer loss into groundwater and the atmosphere is also reduced. This sensor can help farmers maintain uniform plant qualities and provide higher yield by adjusting fertilizer consumption based on a production strategy.

Agri Con GmbH Precision Farming Co.
Jahna, Germany; 49-343-245-2439



● GPS system steers straight in adverse field conditions



The AutoFarm GPS 5000 steering control system provides automatic steering for agricultural machines. The system uses a global positioning system to automatically steer tractors and other farm machines within 1-inch (2.54-centimeter) accuracy. The system is controlled through a touch screen mounted in the vehicle cab. A modular design allows the tractor-mounted unit and display/control unit to be moved from one agricultural machine to another. The small data disk can also be transferred to another tractor or a PC. Multiple units can be operated from one base reference station within a several-mile radius. The electronic system steers the tractor to tight tolerances in adverse field conditions such as fog, dust or poor visibility.

Integrinautics Corp.

Menlo Park, California, USA; 650-833-5600

AE50 OUTSTANDING



INNOVATIONS 2001

● Low-maintenance manifold device increases productivity

The John Deere 1900 Commodity Air Cart now includes a low-maintenance Stationary Double Shoot system that provides high performance seeding product delivery. This compact system mixes metered seeding products with an air stream while eliminating potential manifold air leaks. The design eliminates the need to remove a heavy component when calibrating the metering system and reduces the time for changeover from top to bottom flow. This new function allows users to switch seeding products without difficulty by using a slide that can be locked to ensure accurate product placement. The meter is calibrated by removing a lower plug tray and slipping a lightweight catch pan under the manifold.

John Deere Seeding Group

Moline, Illinois, USA; 309-765-8000

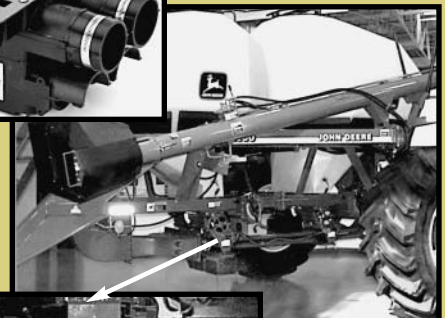

● New sampler triples soil core yield per hour



The Air Probe automatic soil sampler collects an average 240 cores per hour — three times the number drawn using traditional methods. The pneumatic-powered unit can be towed by an all-terrain vehicle, sport utility vehicle or truck. The unit's soil collection sequence begins when a residue rake scrapes away surface debris under the probe, which is then forced into the ground at 550-pounds (247-kilograms) pressure. The probe is lifted and tilted for the sample to be forced into a plastic container by an ejector ram. Each of 20 containers, which are secured in an indexable turntable, can hold up to 10 soil cores. The probe is lubricated by a dripper system to prevent plugging in sticky soil conditions and a spotlight extends sampling time beyond daylight hours.

Furrer FAB Designs

Reynolds, Indiana, USA; 219-984-6505

AE50 OUTSTANDING



INNOVATIONS 2001

● Vario® tractors go beyond the limits

AGCO Corp.'s FENDT™ Vario® series tractors offer advanced technology in front axle and cab suspension, plus a "Variotronic" terminal to control movement and hydraulics. The Vario stepless-drive transmission allows users to operate at any speed up to 31 miles (49.6 kilometers) per hour. Vario gives fluid drives variable speeds and improves mechanical drive efficiency. The Vario series tractors offer smooth, fast acceleration to increase productivity for on-road moves and material transport. The tractors also provide automatic maximum output and cruise control so operators can set optimum speeds for tillage, harvesting and application. The tractors compensate for soil and terrain to improve machine efficiency, decrease operator workload and enhance comfort.

AGCO Corp.

Duluth, Georgia, USA; 770-813-6544



● Irrigation fittings reduce leaks, save time and money

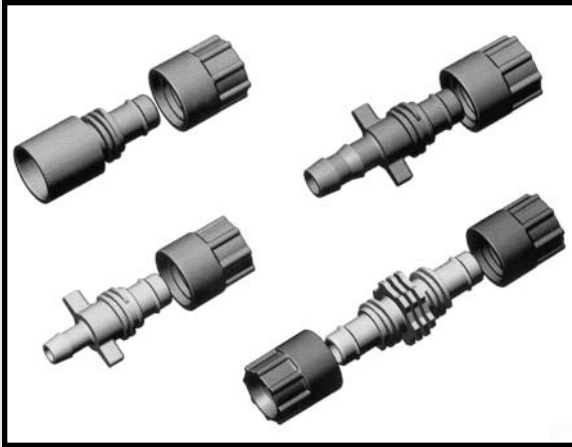

Nelson Grab-On drip fittings for irrigation ensure a leak-free, time-saving connection. The Grab-On design allows visual inspection during installation and features a locking collar that pulls the drip tape onto the fitting barb. Obstruction-free separation of the fitting thread and sealing barb allows for easy threading. Installers can reduce time 10 to 20 percent because the thread pitch provides more closing force than existing fittings. Gripping surfaces on the fitting base and locking collar ensure an easy hand hold. The locking collar and sealing surface tapered design is useful for various irrigation drip tape models and wall thicknesses. Grab-On fittings can join drip tape to polyethylene tubing and PVC pipe fittings and can couple drip tape to drip tape.

Nelson Irrigation Corp.

Walla Walla, Washington, USA; 509-525-7660

AE50 OUTSTANDING



INNOVATIONS 2001

● Cassava grater increases production, reduces injuries

Grating, usually done using a hand rasper, is an important unit operation in cassava processing in Africa. The tedious operation can cause hand injury. The IITA grater increases processing capacity and efficiency in a simple design that is easy to operate and maintain. The IITA can be fabricated locally using local materials. The grater is composed of a stainless rasping mechanism mounted on a drum that forms the grating roller. A feeding hopper mounted atop the drum has an extended base parallel to the roller to regulate rasping action. Adjustable wooden boards fitted to the hopper base control pulp fineness. The grater can be powered by a 3- to 5-horsepower engine. The grater is also effective for mashing pineapple and shredding ginger for juice extraction.

International Institute of Tropical Agriculture
Ibadan, Nigeria; 2-342-241-2626



● Process cools eggs faster to kill bacteria and extend shelf life

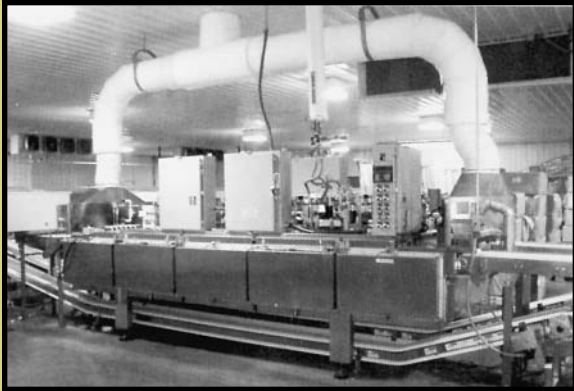

The Praxair Impingement Egg Cooling Tunnel cryogenically cools freshly-lain eggs inline by circulating and impinging cold carbon dioxide onto the egg surface as it moves through the tunnel. Eggs are cooled from 100°F to 45°F (37.7°C to 7.2°C) within 80 seconds. Each tunnel processes up to 3,000 dozen eggs per hour. The system fits into most processing plants and cools eggs before packaging. This processing enhances the food safety of eggs and minimizes *Salmonella enteritidis* (SE) illness potential by preventing SE growth. Most egg processors stack eggs in pallets and it can take up to 14 days to cool the eggs in the center of the stacks. The Praxair system also improves egg quality as shelf life is extended about 30 days more than traditional processes.

Praxair

Burr Ridge, Illinois, USA; 203-837-2476

AE50 OUTSTANDING



INNOVATIONS 2001

● John Deere 900D Draper Platform improves harvest speeds

The 900D Draper Platform increases capacity, improves reliability and increases operator productivity when harvesting small grain and rice. Three platform sizes meet draper customer needs for various crops and conditions. The draper platforms have a rugged structural frame and a heavy-duty, one-piece pick up reel for improved reliability. A double-cut knife system and epicyclic knife drive allow for harvesting speeds up to 11 miles (17.6 kilometers) per hour. The 900D draper platform provides smooth, even feeding to the combine. A new telescoping and indexing drive shaft plus an on-board transport system reduces the time to convert a John Deere draper platform from field operation to transport mode.

John Deere Harvester Works

East Moline, Illinois, USA; 309-765-2177



● Cows choose their own milking times with DeLaval system

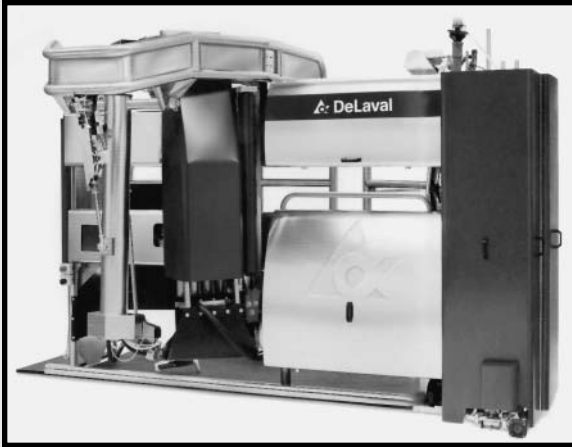

The VMS automatic milking system lets cows decide when and how often they want to be milked. A multi-purpose arm, controlled by advanced electronics, conducts the milking procedure. A laser vision system finds the teat. Milking begins with a cleaning in a separate teat cup that uses tap water and compressed air. The process continues with premilking and teat drying. Four optical indicators measure flow, quantity, milking time and milk quality at each teat. Data is stored and used to calculate a base for detecting abnormal milk. Teat cups are retracted individually when each quarter has been drained of milk. The teats are then sprayed. After the entire milking, teat cups are cleaned inside and rinsed outside and the floor is cleaned.

DeLaval
Tumba, Sweden; +46/8/530 66000

AE50 OUTSTANDING



INNOVATIONS 2001

● GPS helps drivers steer on course

The Outback® S uses GPS to provide driving guidance to a machine operator. In addition to traditional crosstrack, this device adds a steering guide that gives the driver a heading instead of a course error-based indication. This change improves the driver's ability to follow contour lines. The design also makes the Outback S easy to use and install at low cost. The Outback S uses CAN network protocol for future add-ons and outputs NMEA data packets for other applications. The unit installs in any cab in less than 15 minutes. Shortcut buttons and message display have been added. Earlier innovations focused on mapping, yield recording and other field computer applications while the Outback S builds on guidance as the foundation of precision agriculture.

RHS Inc.
Hiawatha, Kansas, USA; 785-742-2949



● Computer navigation goes 3-D for agricultural vehicles

The SiteWinder™ GPS Guidance System for agricultural applications replaces traditional mechanical field guidance marking methods such as foam or disc markers. This electronic system improves efficiency and accuracy while reducing driver fatigue. With guidance and job management capabilities the SiteWinder helps operators use pesticides and fertilizers more efficiently. SiteWinder employs synthetic vision technology to provide the user with a computerized three-dimensional view of a field, rather than a row of lights. A color touch screen allows for navigation in poor visibility or at night. Field data can be transferred to a PC to print field maps and job reports.

Terradox Corp.

Calgary, Alberta, Canada; 403-241-9516

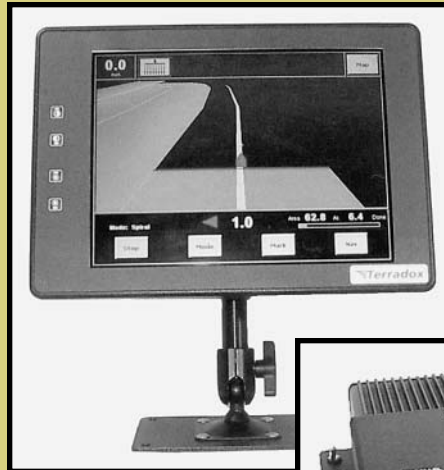

AE50 OUTSTANDING



INNOVATIONS 2001

● New meter uses sunlight to measure chlorophyll



The hand-held, portable Spectrum Chlorophyll Meter makes instant, non-destructive chlorophyll measurements of a plant's reflected light energy. Two high-powered lasers outline the sample area and the measurement is automatically corrected for varying ambient light conditions. A data logger facilitates data collection and permits georeferenced measurements with GPS/DGPS. Data can be downloaded to a personal computer for more statistical analysis. When unfavorable growth conditions result in plant physiological stress, leaf chlorophyll content typically changes. Measuring leaf chlorophyll content provides an indicator of such stress. The meter allows for non-destructive field measurement of chlorophyll with no light source other than the sun.

Spectrum Technologies, Inc.

Plainfield, Illinois, USA; 815-436-4440

● Narrow tractors fit in tight spots to make land use more efficient



The New Holland Model TN-V tractors are compact, powerful, versatile, narrow tractors for spraying, mowing, trimming and hauling in vineyards and orchards. Large-tractor technology and options are housed in a tractor package as narrow as 39 inches (99 centimeters) wide. Tighter crop row spacing allows for more product to be planted per acre. An automatic traction management system automatically engages and disengages the front-wheel drive to reduce operator fatigue. This feature can be combined with other high-productivity options such as electronic draft control to increase fuel savings and reduce work time. Three tractor models provide 42, 52 and 62 PTO horsepower with up to 36 percent torque rise and a three-cylinder engine.

New Holland North America

New Holland, Pennsylvania, USA; 717-355-3663

AE50 OUTSTANDING



INNOVATIONS 2001

● Non-friction clutch saves down time, increases production rates

The TorQmaster automatic clutch combines the features of a modular automatic clutch with 60 degrees of free movement. The clutch's modular nature allows the manufacturer to tailor torque protection to an application, balancing size and capacity. The automatic clutch uses no friction to control torque. A wedge design allows the clutch to slip continuously without generating damaging heat. The rotational freedom of the clutch provides free movement that allows tractor yoke splines to be aligned with the tractor PTO shaft splines so hook-up is easy. The TorQmaster automatic clutch is used on the implement input shaft. Various torque settings are available for a range of universal joint sizes.

Weasler Engineering Inc.

West Bend, Wisconsin, USA; 262-338-2161

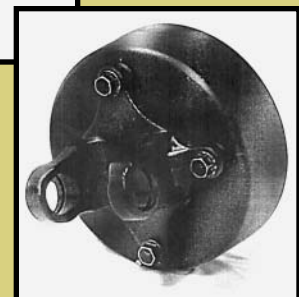

● Open circuit axial piston pump is smaller for a more power-dense package

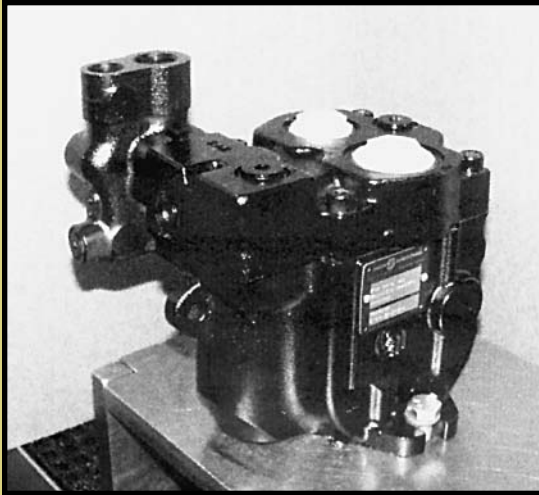

The Series 45, 38cc and 45cc open circuit pump is used with other fluid power products to transfer and control hydraulic power. The pump provides a variable flow rate with two choices of maximum displacement in one package. The pump is a compact, high-power density unit using the parallel axial piston/slipper concept with a rotatable swash plate. The pump powers work functions in agricultural tractors, sprayers and combines, plus construction equipment such as small loaders, mini-excavators and large skid steer loaders. Pump features include quiet operation, a small power-dense package and robust design. Controls provide several methods for regulating output flow from the pump.

Sauer-Danfoss
Ames, Iowa, USA; 515-239-6313

AE50 OUTSTANDING



INNOVATIONS 2001

● Mini device makes water activity measurement easy

Pawkit is a small, fast, portable instrument for health inspectors, food scientists and quality control personnel measuring water activity in the field or outside a laboratory environment. A new opening and closing mechanism in Pawkit combines a sensor and display into one unit to offer optimal portability. Pawkit is up to 85 percent smaller and 73 percent lighter than similar commercially available portable water activity meters. This lightweight instrument displays readings over an entire water activity range accurately in five minutes. The self-contained battery-operated Pawkit is 4 inches (10 centimeters) long and weighs 4 ounces (115 grams). The kit includes a carrying case, sample cups and standards.

Decagon Devices, Inc.
Pullman, Washington, USA; 509-332-2756

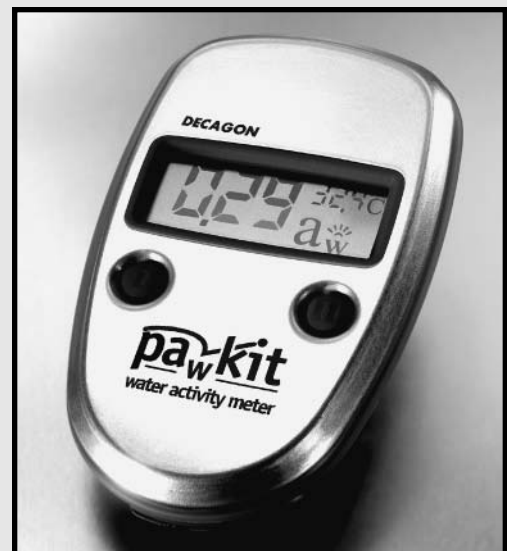

● Operators can spray at speeds up to 20 miles per hour

The John Deere 4710 Self-Propelled Sprayer for large farm and commercial applicators has a 200 horsepower, John Deere Powertech engine, four-wheel independent-strut suspension and 800-gallon (3,040-liter) solution tank. The SprayStar vehicle and rate control system integrated into the design controls many machine and solution system functions in an easy-to-read monitor. The SprayStar controller allows the user to set three programmable rates to match spraying requirements on the go from 4 to 94 gallons (15 to 357 liters) per minute. SprayStar records area, volume and spraying time. Parallel tracking guides the operator through the field and can pinpoint any location within 10 inches (25.4 centimeters).



John Deere Des Moines Works
Ankeny, Iowa, USA; 515-289-3190



AE50 OUTSTANDING



INNOVATIONS 2001

● Singulator does job of planter and drill combined

The 3N-3010P folding precision singulating system brings Singulator Plus metering to a 30-foot (900-centimeter) -width machine. The new folding mechanism reduces its wide working width to nearly 50 percent for transport. The unit features twin-contact drive wheels that operate each half of the drill and allow for a simple drive system without mechanical clutches. The unit singulates various seeds including corn, soybeans, cotton and milo. It also can volumetrically meter seeds such as wheat, rice, rye and barley. The unit does the job of a planter and a drill combined. It also accurately meters seeds at field speeds up to 8 miles (12.8 kilometers) per hour. The 3N-3010P is offered with two parallel arm opener styles with enclosed seed tubes and flaps.

Great Plains Manufacturing
Assaria, Kansas, USA; 785-667-7763

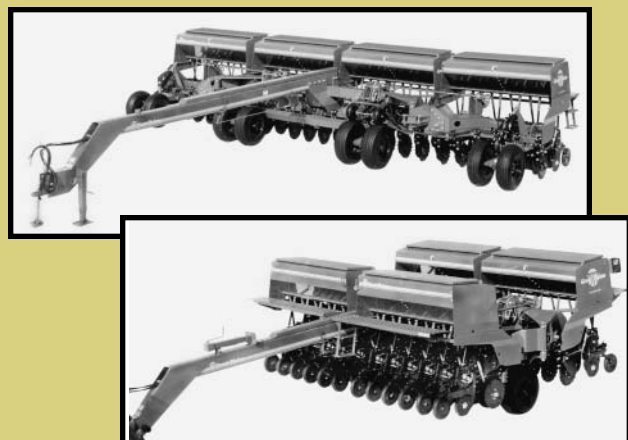

● Combination valve/sprinkler gun saves water, energy costs



The Nelson 800P + SR75A valve/gun combines a valve and sprinkler gun into one unit. The 800P provides hydraulic control with no electric solenoid. The design improves reliability as the valve and sprinkler gun operate automatically using a booster pump. The SR75A sprinkler is smaller than earlier center pivot end gun models and operates with 35 percent less water to fit modern center pivot systems that also use less water. The valve and gun combination offers a pressure regulator option to stabilize variations in the center pivot system's outer area. Reduced pressure can save up to 20 percent of operating energy. The sprinkler has a low-angle trajectory setting to decrease the amount of water lost to wind drift.

Nelson Irrigation Corp.
Walla Walla, Washington, USA; 509-525-7660

AE50 OUTSTANDING



INNOVATIONS 2001

● Swing back suspension creates less frame stress on mower

The MCI030 DiscPro® center pivot disc mower conditioner can mow hay or forage either to the right or left of the tractor. This process allows the operator to go back and forth in a field instead of driving completely around a field in one direction. The machine tongue is positioned with trunnion hydraulic cylinders. A swivel gearbox at the tractor end of the tongue allows for tighter turns. This machine also incorporates a swing back suspension system that pulls the header over obstacles instead of pushing into them. The result is less stress on the frame. The conditioning system is modular enabling either steel rollers or a tine rotor to be installed with minimum assembly time.

Vermeer Manufacturing
Pella, Iowa, USA; 641-628-3141



● Transporter loads large equipment without destroying turf



The New Holland Discbine® Transporter provides safe endwise transportation of the New Holland Model 1441/1442 Discbine® Center Pivot Tongue Disc Mower-Conditioners in a package less than 10 feet (300 centimeters) wide. The implement is backed onto the transporter and the tongue rotated 85 degrees from the standard direction of travel to tow the whole package down highways, country lanes and through narrow field gates. Once the implement is ready for loading, the operator can load and go without leaving the tractor seat. The transporter features automatic loading ramp raising, implement securing to the transporter and tongue latching in the endwise position. A castor wheel vs. a support stand design preserves turf at loading location.

New Holland North America
New Holland, Pennsylvania, USA; 717-355-3663

AE50 OUTSTANDING



INNOVATIONS 2001

● STX tractors balance power with structure

STX Steiger tractors come in two chassis sizes to apply proper size and weight balance to engine horsepower and offer several variations for Accusteer, Quadtrac and Scraper versions. Accusteer models have an additional pivot in front of the cab, providing 10 degrees more articulation angle to total 52 degrees. Quadtrac models offer four independent tracks for better traction and flotation. Scraper versions are equipped with scraper drawbars, tow cables and laser-ready controls. Large chassis performance is enhanced with 375 and 440 horsepower Cummins engines. Small chassis models have 275 and 325 horsepower engines. The tractors improve productivity and versatility for operators.

CNH Global Fargo
Fargo, North Dakota, USA; 701-293-4400



● Operator has automated wrapping choices with new baler



Variable Chamber Round Balers feature a state-of-the-art, customer-friendly feedback and control system. On-board hydraulics provide a self-contained system that only depends on the tractor for a power take off and 12-volt electrical source. From the tractor seat, an operator can preselect variables such as bale size, wrapping medium and amount of wrap. A choice is also available to either automatically start the wrapping function or allow for an operator-activated start. The base baler features a wide pickup to eliminate the need for gathering wheels and producing solid, square-shouldered bales. The optional advanced mesh wrap system is wider than the bale chamber to provide mesh coverage to the bale edge with a positive mesh starting system.

Hay & Forage Industries
Hesston, Kansas, USA; 316-327-6603

AE50 OUTSTANDING



INNOVATIONS 2001

● John Deere GPS goes global

The John Deere StarFire™ Position Receiver and worldwide StarFire Network work together to provide geographical positioning for use in mobile agricultural operations. The receiver and network are used with John Deere GreenStar® precision farming systems in mapping, variable rate applications and guidance applications. The StarFire Position Receiver contains a low-cost antenna for GPS, WAAS and INMARSAT satellite signals plus a dual-frequency GPS engine designed and built by John Deere. The StarFire Network combines John Deere's DGPS capabilities with NASA's Jet Propulsion Laboratory to create an integrated positioning system that provides accurate, real-time measurements globally.

John Deere Ag Management Solutions
Urbandale, Iowa, USA; 515-331-7450



● System manages crop residue in a single field operation



The Rome-Pegasus is a post-harvest system for managing cotton crop residue. Conventional cotton crop management systems require numerous field operations to achieve what the Rome-Pegasus does in one pass. The unit is a three-point-hitch-mounted tillage implement pulled through soil behind a tractor. As its shank apparatus moves through soil, a temporary furrow is formed. A forward-mounted root knife cuts the plant tap root and an embedding tool pushes the stalk and root into the collapsing furrow. The cotton residue is buried into a rope-like organic bundle incorporated into the soil. Closing disks cover the material to form a uniform seedbed ready for planting next year's crop. All functions are completed in a single field pass.

Rome Plow Co.
Oakton, Virginia, USA; 703-338-7890

AE50 OUTSTANDING



INNOVATIONS 2001

● Eco-Chipper gives operator better control

The four-wheeled Eco-Chipper pruning vehicle chips orchard waste up to 5 inches (12.7 centimeters) in diameter into fingernail-size pieces to decompose on the orchard floor before harvest time. The chipper is powered by a rearward-facing 260 horsepower Cummins engine. The unit's front wheels are driven hydrostatically and the rear wheels steer. The Eco-Chipper's cab is positioned over six feed rolls that guide prunings into the chipper drum. The chipper's plate glass floor allows viewing of the rollers and feeding process. Foot pedals control the hydrostatic pump. The operator steers with the left hand and controls feed and other functions with the right.

Jackrabbit
Ripon, California, USA; 209-599-6118



● Ergonomic Allegro field computer's solid-state hard disk provides data protection

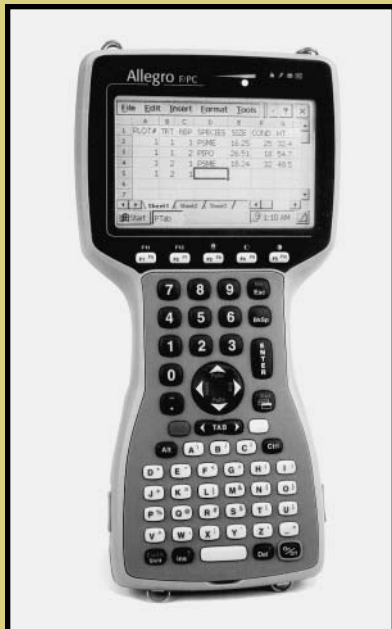

The Allegro Field PC™ provides a rugged, hand-held computing and data collection platform. The powerful, ergonomically-designed Field PC is suited to field data collection in agriculture and forestry. The Allegro, which runs Windows CE and DOS applications, is sealed to withstand temperature and moisture extremes of outdoor working environments. The unit is designed for agricultural engineers, agronomists and foresters who use mobile hand-held computers for outdoor data collection. The Allegro mounts into a cradle for on-vehicle applications including yield mapping, boundary delineation work and soil sampling navigation. The disk-on-chip storage technology prevents data loss even — without battery power.

HarvestMaster Inc.
Logan, Utah, USA; 435-753-1881

AE50 OUTSTANDING



INNOVATIONS 2001

● BB900 makes more marketable bales

The New Holland Model BB900 Three-Tie Baler processes and packages forage crops and crop residues into dense, consistent, marketable bales. The BB900 has an improved mainframe design six times more durable than its predecessor to handle increased loads. A redesigned pickup reduces plugging and a longer stroke plunger creates more consistent bales. The BB900 provides performance monitors and controls in the towing vehicle. The remote control box includes warning lights for engine pressure and temperature, and controls for tongue shift, pickup lift, bale density and lights. The BB900 features a wide pickup, which feeds into an in-line feeder system to save leaves while making solid, uniform bales in all crop conditions.

New Holland North America
New Holland, Pennsylvania, USA; 717-355-3663



● System moves grain from side to side for consistent drying within stacked grain dryers

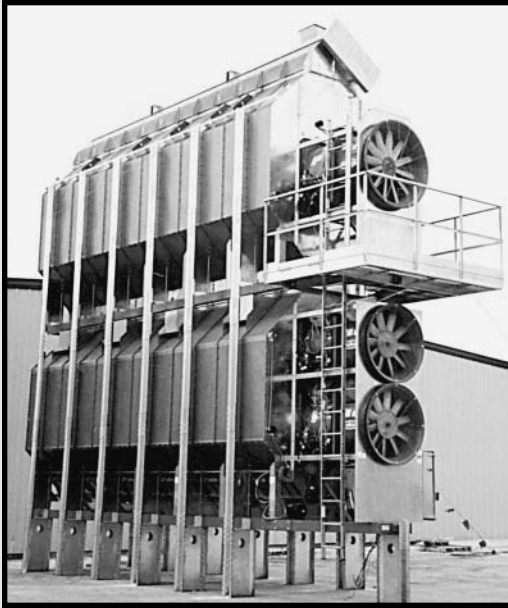

The Sukup Cross-Over system inverts grain in two-unit, vertically stacked dryers as it moves from the upper to lower unit to improve grain quality and maintain consistent moisture content. Computer controls allow the operator to set output specifications. The system moves grain from side to side in the dryer and within the column to reduce the effects of weather conditions. Wind can affect moisture content of grain because the side of the dryer facing the wind will be cooler so drying will be less thorough than on the opposite side. Rain and snow add to this problem. Inverting the grain within the column equalizes the temperature in the outer and inner grain because inner grain is more susceptible to overdrying.

Sukup Manufacturing Co.
Sheffield, Iowa, USA; 641-892-4222

AE50 OUTSTANDING



INNOVATIONS 2001

● Precise depth control give chisel plow better results

The 2400 Chisel Plow tillage machine provides accurate depth control for improved moisture conservation, fertilizer placement and soil management. A patented AccuDepth control system adjusts on the go to increase productivity and reduce work for operators. A floating hitch, and the frame strength of the patented tube-through-tube design, plus wheel package placement provide tillage depth consistency from front to back and side to side. AccuDepth control uses individual wheel sensors and electronic circuitry to level the frame and maintain depth measurements. The 2400 chisel plow reduces fuel consumption, shatters compacted soil layers, mixes soil and maintains accurate depth control.

John Deere Des Moines Works
Des Moines, Iowa, USA; 515-289-3163



● Radial Pin Clutch accommodates higher settings and larger shafts



The K40 Series Radial Pin Clutch expands on Walterscheid's K30 clutch line, which features rows of spring-loaded cams seated in the clutch housing's axial grooves. During overload, these cams are pushed back against the spring force and slip repeatedly across the housing's grooves until an obstruction is overcome. Torque setting can be tailored to an application by varying the number of rows, cams or springs. The K40 series allows higher settings and larger shafts than the K30 series and can be configured for torque settings at speeds up to 300 rpm. The clutch generates less heat and is more compact than a friction clutch of similar capacities. It also provides an audible warning during overload.

GKN Walterscheid Inc.
Burr Ridge, Illinois, USA; 630-887-7022

AE50 OUTSTANDING



INNOVATIONS 2001

● Controlling irrigation pressure is MRDC goal

The MRDC Mini-Regulator Drain-Check pressure control for irrigation functions as a drain check valve and a regulator for uniform flow. The MRDC regulates pressure in irrigation systems at the emission point at the sprinkler or drip line inlet. This control ensures consistent flow and distribution characteristics at each sprinkler and drip line. A patented drain-check remains closed until pressure is available for irrigation. By improving uniformity, irrigation can be more precisely timed to conserve water. The drain check saves water by preventing system drainage to avoid crop damage and erosion. As growers irrigate more precisely they can reduce water, fertilizer and chemical use.

Nelson Irrigation Corp.
Walla Walla, Washington, USA; 509-525-7660



● Cost-effective dairy cow supplement more convenient for producers

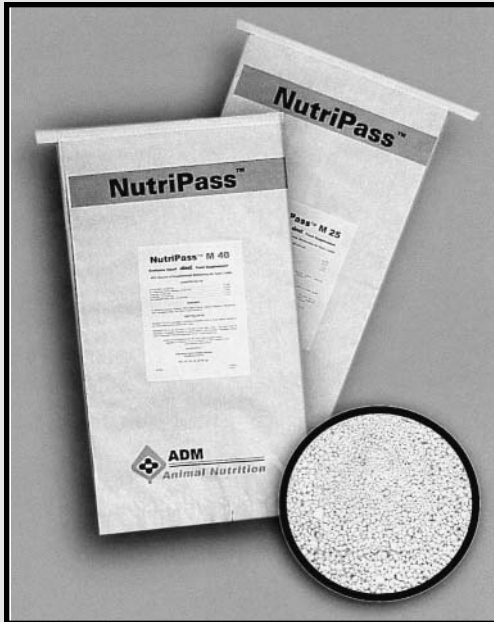

NutriPass™ M25 and NutriPass™ M40 are dry flowable forms of Alimet®, a supplemental rumen bypass source of the amino acid methionine, for dairy cattle. Alimet® is a product of Novus International Inc. and is methionine hydroxy analog (MHA). The MHA concentration in M25 is 25 percent and in M40 is 40 percent. A process developed by ADM MoorMan's to produce the supplement uses readily-available organic carriers, which reduces the product cost about 20 percent compared to competing products. The MHA is slowly degraded in the rumen and converted to L-methionine by organ tissues. The resulting increase in available methionine increases milk production in lactating cows. These products are manufactured using a process in which methionine can be delivered in a safe, convenient, easy-to-handle form to dairy producers.

ADM MoorMan's Inc.
Quincy, Illinois, USA; 217-231-2441

AE50 OUTSTANDING



INNOVATIONS 2001

● Combined injection/broadcast system overcomes manure applicator problems

The AerWay SSD Slurry Manure Applicator is a pull-type or mounted implement with swing arms that rapidly and precisely spread slurry manure on land. The unit completes its task with less nutrient loss and odor emission experienced using traditional injection and broadcast systems. Manure pumped from the SSD tank or umbilical hose is double chopped then divided into multiple hoses. Each hose ends with a soft rubber emitter that opens above the soil. The emitters are positioned behind ground-driven, rotating tines that dig vertical slots in the soil. Manure flow to the emitters is automatically shut off when the implement is raised. This implement can be used to spread manure onto conventional-till and minimum-till cropland, grassland and rough pasture.

Holland Equipment, Ltd.
Norwich, Ontario, Canada; 800-457-8310



● Hydraulic down pressure a new feature on tillage tool



The 2700 Mulch Ripper combination primary tillage tool sizes residue, shatters sub-soil compaction, mixes mulch with soil and conditions the soil surface — all in one pass. An active hydraulic down pressure system protects mulching gangs from obstructions. An optional rear disk conditioner allows the operator to achieve smooth or rough surface profiles. The 2700 provides flexibility in residue management, soil fracture and surface profile management. Mulching disk and rear disk conditioner depths are hydraulically adjustable and can be raised completely out of the ground at all ripping depths. Flexibility is a benefit to producers who farm land with varied erosion conditions.

John Deere Des Moines Works
Des Moines, Iowa, USA; 515-289-3389

AE50 OUTSTANDING



INNOVATIONS 2001

● PJS sorts fresh and processed berries

The Pacific Jet Sorter (PJS) uses machine vision to color sort fresh and processed blueberries. Color CCD cameras and proprietary vision boards automatically pick out unwanted, off-color blueberries, which reduces labor without damaging good berries. The PJS works with dry, fresh berries, wet berries for processing and frozen berries. It also ejects defects such as leaves, stems, cardboard, plastic and insects. The PJS is made of stainless steel and is small enough to fit in the back of a standard pick-up truck. The unit has a built-in air regulator and filter system. PJS sorts up to 12,600 pounds (5,670 kilograms) per hour of frozen blueberries and can be used to color sort cranberries and coffee in the husk.

K & D Agriculture Inc.
Bow, Washington, USA; 360-757-4385

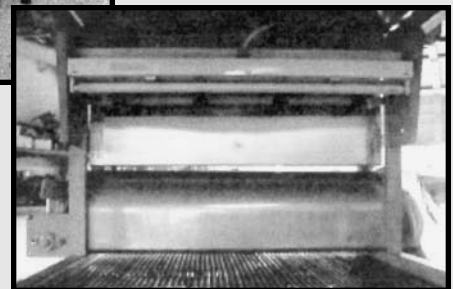

AE50 2001 WINNERS INDEX

ADM MoorMan's Inc.
**NutriPass™ M25 and
NutriPass™ M40**
page 21

AGCO Corp.
Vario® tractors
page 6

Agri Con GmbH Precision
Farming Co.
Hydro N-Sensor
page 4

CNH Global Fargo
STX Steiger tractors
page 15

Decagon Devices, Inc.
Pawkit
page 12

DeLaval
**VMS automatic milking
system**
page 9

Furrer FAB Designs
Air Probe
page 6

GKN Walterscheid Inc.
**K40 Series Radial Pin
Clutch**
page 20

Great Plains Manufacturing
**3N-3010P singulating
system**
page 13

HarvestMaster Inc.
Allegro Field PC™
page 18

Hay & Forage Industries
**Variable Chamber
Round Balers**
page 16

Holland Equipment, Ltd.
**AerWay SSD Slurry
Manure Applicator**
page 21

IntegriNautics Corp.
AutoFarm GPS 5000
page 5

International Institute of
Tropical Agriculture
IITA Cassava grater
page 7

Jackrabbit
Eco-Chipper
page 17

John Deere Ag Management
Solutions
**StarFire™ Position
Receiver and StarFire
Network**
page 16

John Deere Des Moines
Works
**4710 Self-Propelled
Sprayer**
page 13

John Deere Des Moines
Works
2400 Chisel Plow
page 19

John Deere Des Moines
Works
2700 Mulch Ripper
page 22

John Deere Harvester
Works
900D Draper Platform
page 8

John Deere Seeding Group
**1900 Commodity Air
Cart**
page 5

K & D Agriculture Inc.
Pacific Jet Sorter
page 22

Nelson Irrigation Corp.
Grab-On drip fittings
page 7

Nelson Irrigation Corp.
800P + SR75A valve/gun
page 14

Nelson Irrigation Corp.
**MRDC Mini-Regulator
Drain-Check**
page 20

New Holland North
America
Model TN-V tractors
page 11

New Holland North
America
Discbine® Transporter
page 15

New Holland North
America
**Model BB900 Three-Tie
Baler**
page 18

Praxair
**Praxair Impingement
Egg Cooling Tunnel**
page 8

RHS Inc.
Outback® S
page 9

Rome Plow Co.
Rome-Pegasus
page 17

Sauer-Danfoss
Series 45, 38cc and 45cc
page 12

Spectrum Technologies, Inc.
**Spectrum Chlorophyll
Meter**
page 10

Sukup Manufacturing Co.
Sukup Cross-Over
page 19

Terradox Corp.
**SiteWinder™ GPS
Guidance System**
page 10

Titan Tire Corp.
**LSW610R470 G30 Turf
Tire**
page 4

Vermeer Manufacturing
MC1030 DiscPro®
page 14

Weasler Engineering Inc.
TorQmaster
page 11



**AE50
Outstanding Innovations 2001**

**Published by
ASAE – The Society for engineering
in agricultural, food, and biological systems
2950 Niles Road, St. Joseph, MI 49085-9659, USA
616-429-0300 • fax 616-429-3852 • hq@asae.org • www.asae.org**